

SHELLSHOCK



NTSC U/C

PlayStation



KIDS TO ADULTS
KA
AGES 6+

SLUS-00031



WARNING

READ BEFORE USING YOUR PLAYSTATION GAME CONSOLE

A very small percentage of individuals may experience epileptic seizures when exposed to certain light patterns or flashing lights. Exposure to certain patterns or backgrounds on a television screen or while playing video games, including games played on the PlayStation game console, may induce an epileptic seizure or epilepsy. If you, or anyone in your family, has an epileptic condition, consult your physician prior to playing. If you experience any of the following symptoms while playing a video game—dizziness, altered vision, eye or muscle twitches, loss of awareness, disorientation, any involuntary movement, or convulsions—**IMMEDIATELY** discontinue use and consult your physician before resuming play.

WARNING TO OWNERS OF PROJECTION TELEVISIONS

Still pictures or images may cause permanent picture-tube damage or mark the phosphor of the CRT. Avoid repeated or extended use of video games on large screen projection televisions. Refer to your projection TV instruction manual for more details.

HANDLING YOUR PLAYSTATION DISC

- This compact disc is intended for use only with the PlayStation game console.
- Do not bend it, crush it or submerge it in liquids.
- Do not leave it in direct sunlight or near a radiator or other source of heat.
- Be sure to take an occasional rest break during extended play.
- Keep this compact disc clean. Always hold the disc by the edges and keep it in its protective case when not in use.
- Clean the disc with a lint-free, soft, dry cloth, wiping in straight lines from center to outer edge. Never use solvents or abrasive cleaners.

SHELLSHOCK

CONTENTS

SETTING UP	2
CONTROLS	3
QUITTING THE GAME	4
JUST KEEPING THE PEACE	4
THIS IS THE PITCH	5
DA WARDENZ	6
THE M-13 PREDATOR BATTLETANK	8
STARTIN' OUT	8
THE PEN	8
GETTIN' ROUND THE PEN	9
HQ LOCATIONS	9
MISSION BRIEFINGS	12
IN THE TANK	13
ARMOR	14
WEAPONS	15
TANK UPGRADES	16
AIR SUPPORT	18
HOSTAGES	19
ENEMY VEHICLES	19
PICK-UPS	21
MISSION STATS.	21
CREDITS	22

SETTING UP

CONSOLE

TOP VIEW

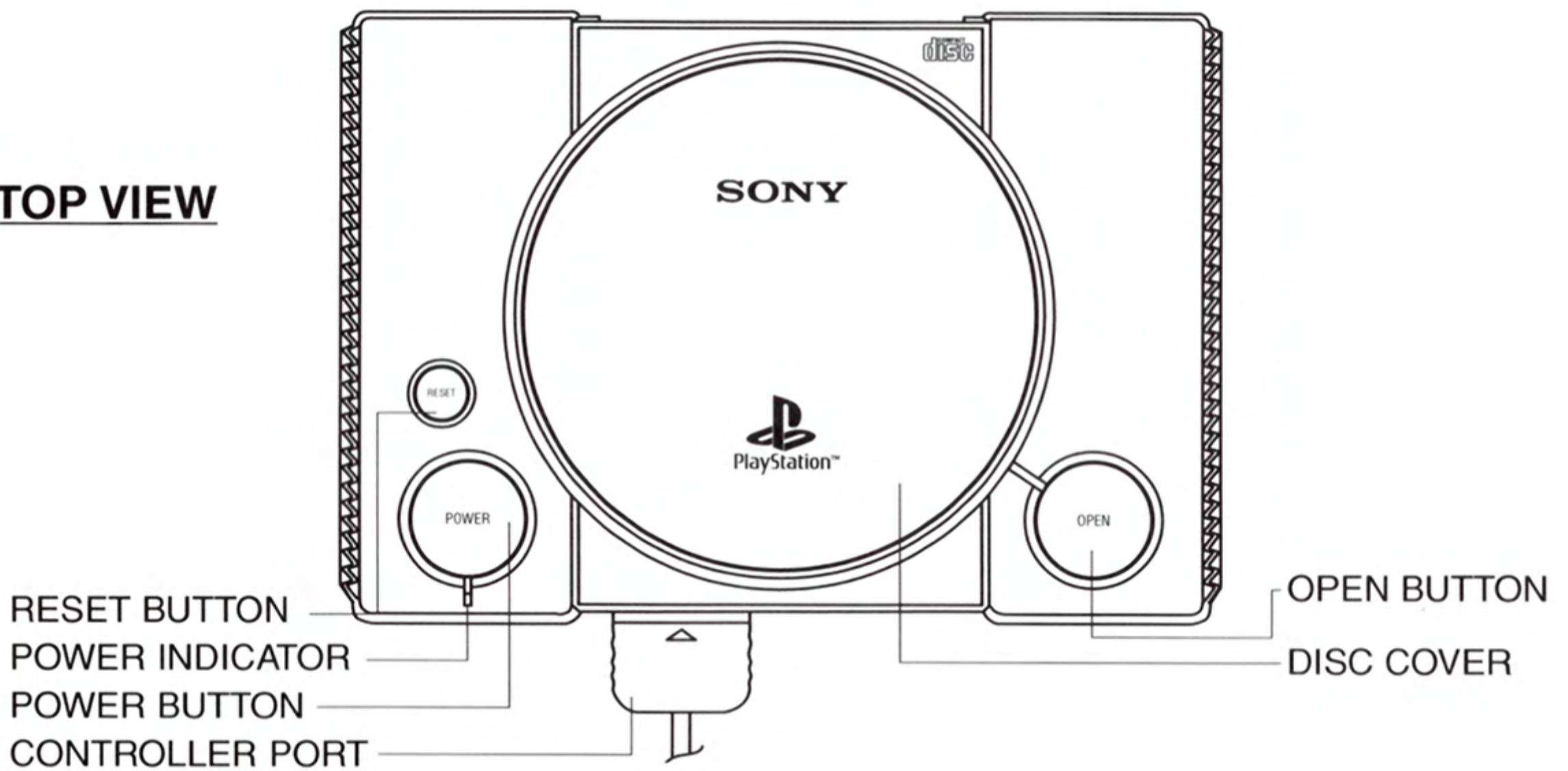

FRONT VIEW

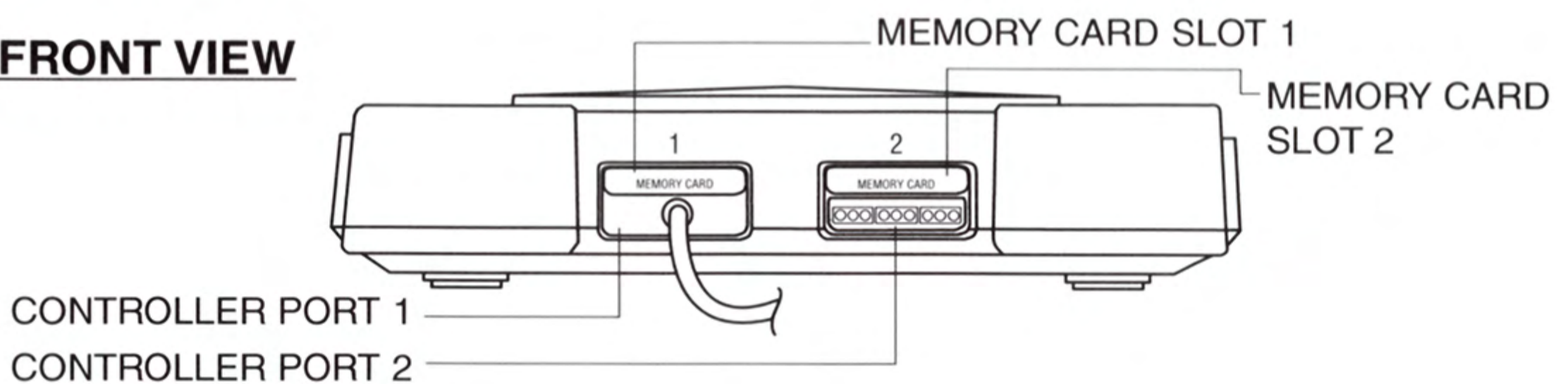

1. Set up your PlayStation game console according to the instructions in its Instruction Manual.
2. Insert the Shellshock disc and close the CD cover.
3. Insert a game controller and turn the PlayStation game console on. Follow the on-screen instructions to start a game.

CONTROLS

TOP VIEW

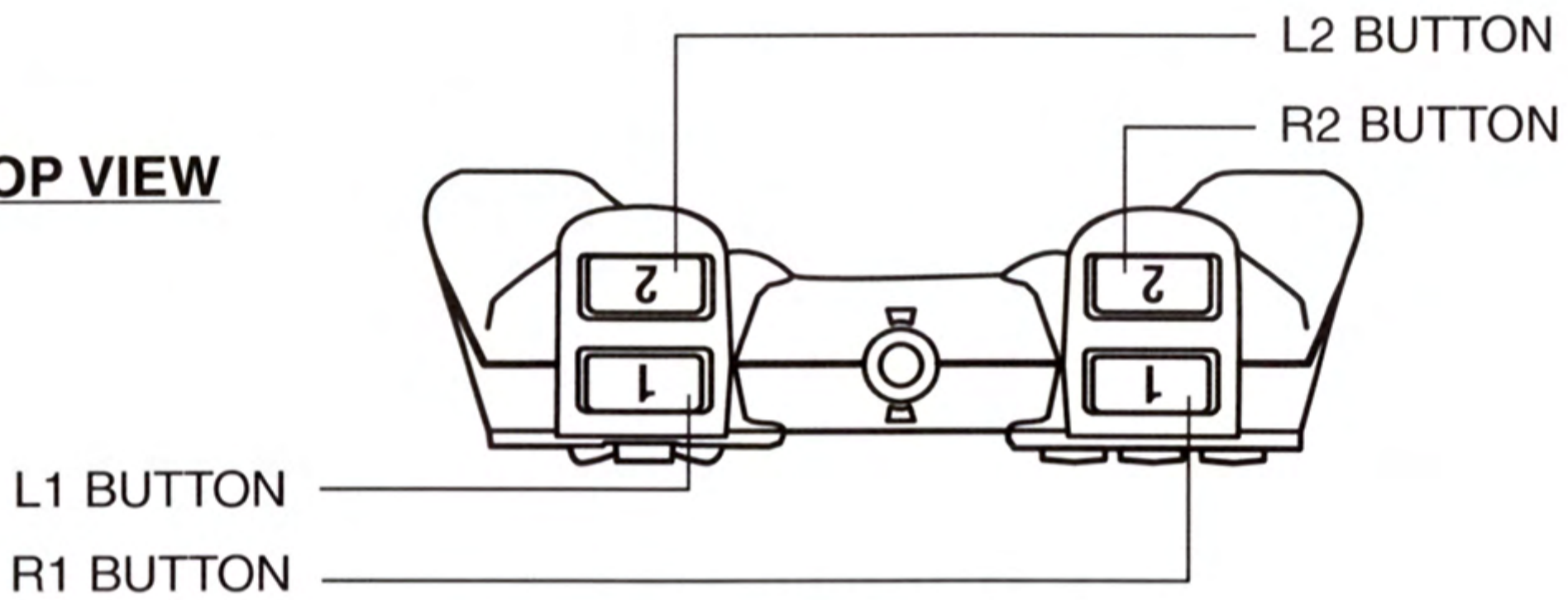

FRONT VIEW

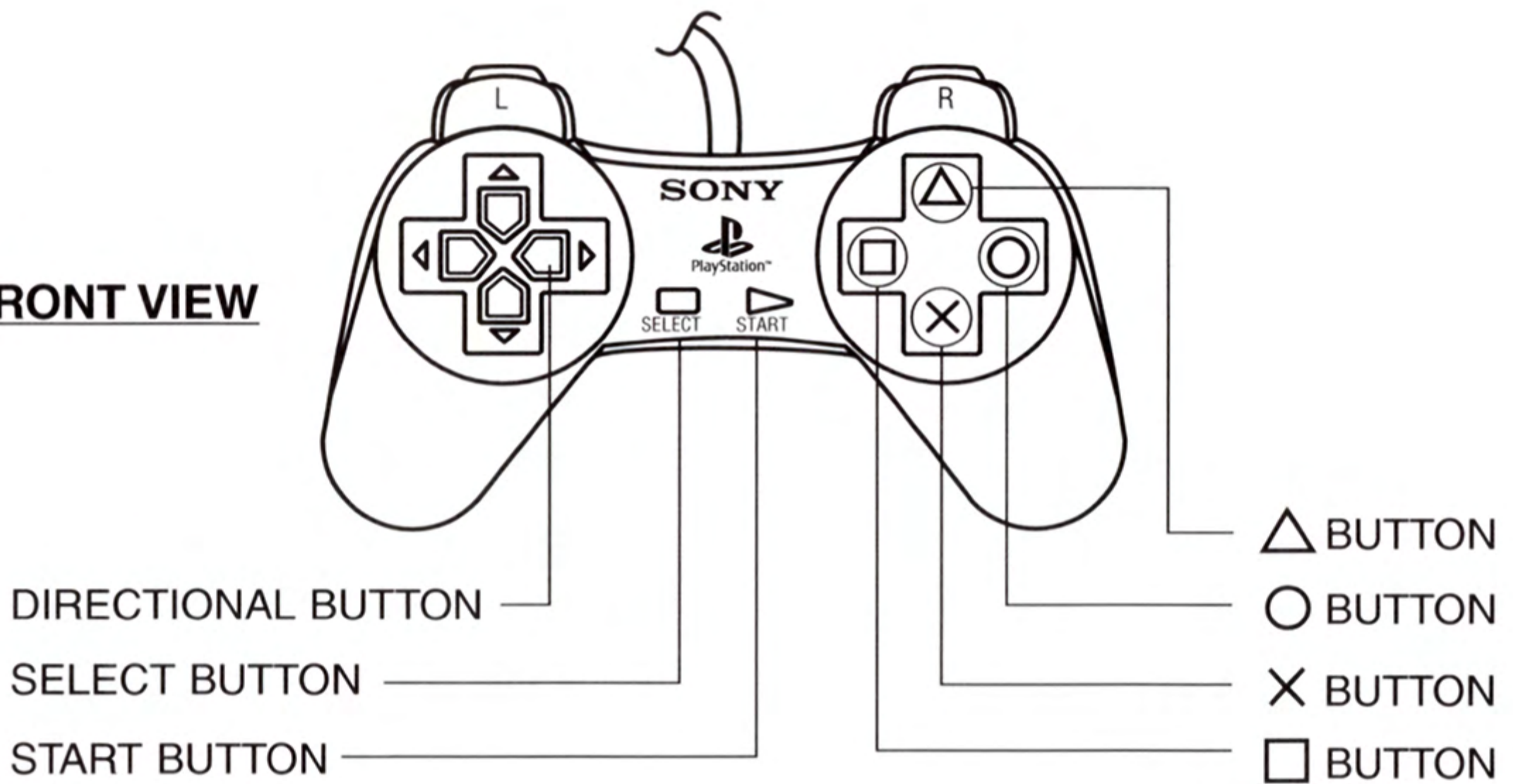

- | | |
|--------------------|----------------------|
| D-Pad Up | Forward Drive |
| D-Pad Down | Reverse Drive |
| D-Pad Right | Steer Right |
| D-Pad Left | Steer Left |
| R1+R | Handbrake Turn Right |
| L1+L | Handbrake Turn Left |

L2	Moves Turret Left
R2	Moves Turret Right
L2+R2	Re-centers Turret
X	Fire currently selected weapon
□	Toggles through available weapons
▲	Displays Tactical Map
O	Selects alternative target
Select	Brings up Options
Start	Pauses / Unpauses the game

QUITTING THE GAME

To return to the Title Screen, hold down the Select Button and press and hold down the Start Button for 2 seconds.

JUST KEEPING THE PEACE

Mostvia Vatska, 1994. A Special Forces unit protecting a civilian convoy, comes under heavy artillery fire. All requests for tactical support from US Intelligence are denied and the unit declared expendable. The convoy is destroyed. Only five men survive.

New York City, 1997. A five-man commando unit is operating out of the derelict state correctional facility on Jackson Island, New York. Calling themselves 'Da Wardenz', they are uncompromisingly committed to combating terrorism, fighting oppression and exposing corruption worldwide.

In a world without justice, they're the last line of defense.

THIS IS THE PITCH



A note from Dogg Tag:

SHELLSHOCK puts you right smack in the middle of the action. You are now a rookie member of the baddest commando tank force you'll ever meet—Da Wardenz.

The object of the game is to serve a tour of duty with these five guys, proving yourself, in their and your own eyes, as you battle your way through a series of missions in a variety of fictionalized, real-world locations. From the freezing forests of Mostvia Vatska, to the steaming Paranaguan jungle, you're gonna have a real tough time of it.

Armed only with an M-13 Predator battletank and several thousand pounds of heavy-duty ordnance, you're gonna find your skills tested to the absolute max.

As the tour of duty progresses—and if you're still breathin'—you'll get the opportunity to upgrade your tank and improve its performance, armor and armaments.

But before we get down to the business at hand, let me introduce to you the guys who are gonna be watchin' your back (so long as you watch theirs):



DA WARDENZ

Classified

The Man

Real name: RESTRICTED

Rank: COLONEL

Age: 27yrs

The leader of Da Wardenz.

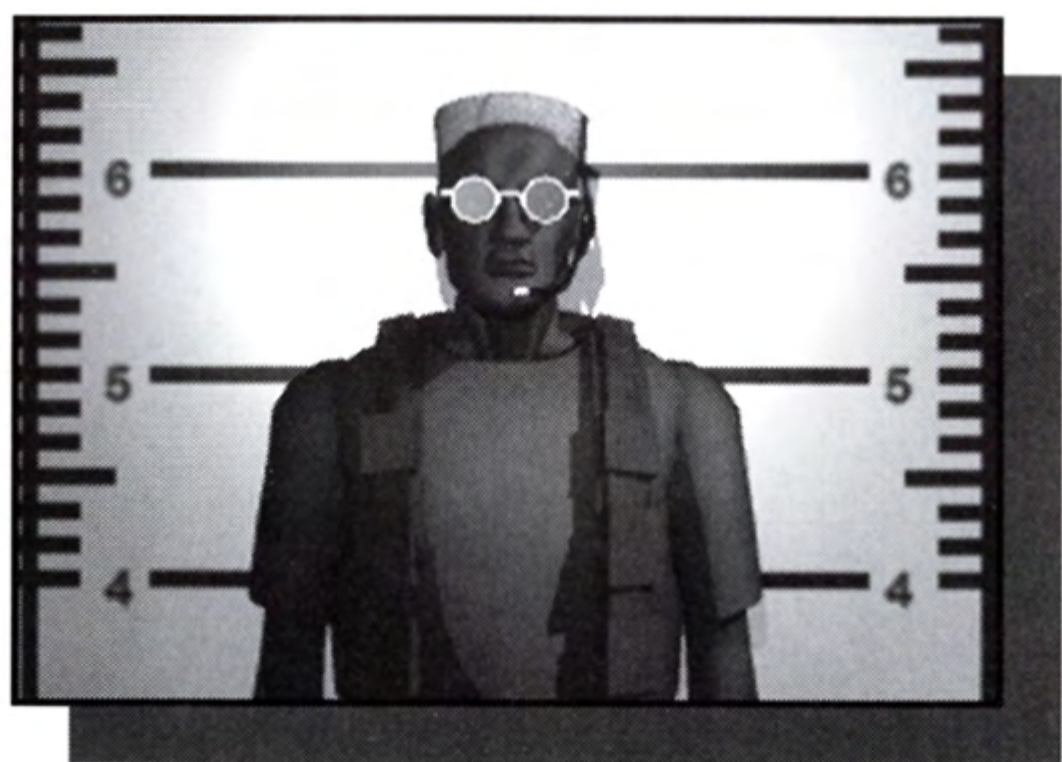

Earshot

Real name: DARNELL JONES

Rank: SERGEANT

Age: 31yrs

Earshot is in charge of Communications and Tactics and will appear in-game to give you messages relating to your objectives etc. He's something of

a pseudo-intellectual, so don't go asking him about the existentialism of Jean Paul Sartre, or you'll most likely wind up with a 20,000 word thesis on the subject.

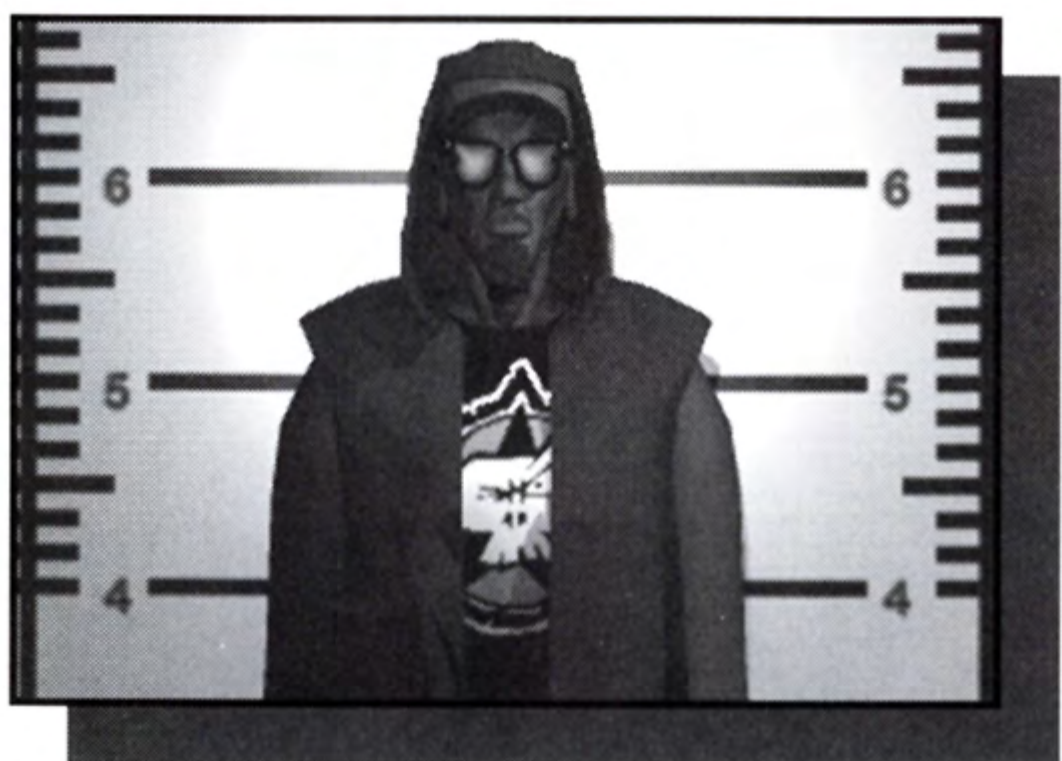

D-Tour

Real name: CECIL COLES

Rank: PRIVATE FIRST-CLASS

Age: 29yrs

A onetime member of the Special Forces unit that the other members of Da Wardenz were also attached to, he is an expert with armored vehicles. D-Tour is

your buddy throughout the tour of duty that you serve with Da Wardenz, having been assigned to accompany you in the tank during your missions. He will appear chiefly in-game.

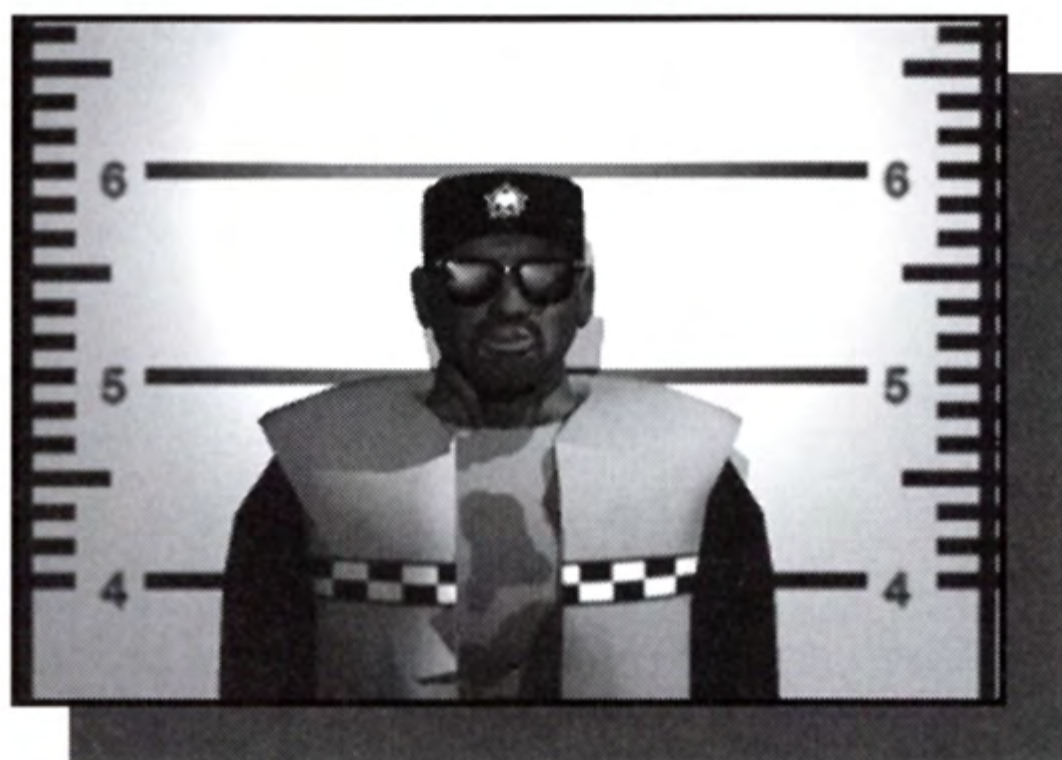

Predator tank. Go see Props if you want to equip your tank—so long as you're within his budget.

Props

Real name: ALVIN FIELDER

Rank: CORPORAL

Age: 24yrs

Props is an ordnance and supply specialist (guns 'n' stuff). He's at home in the workshop, where he controls the supply of equipment and ammunition for your

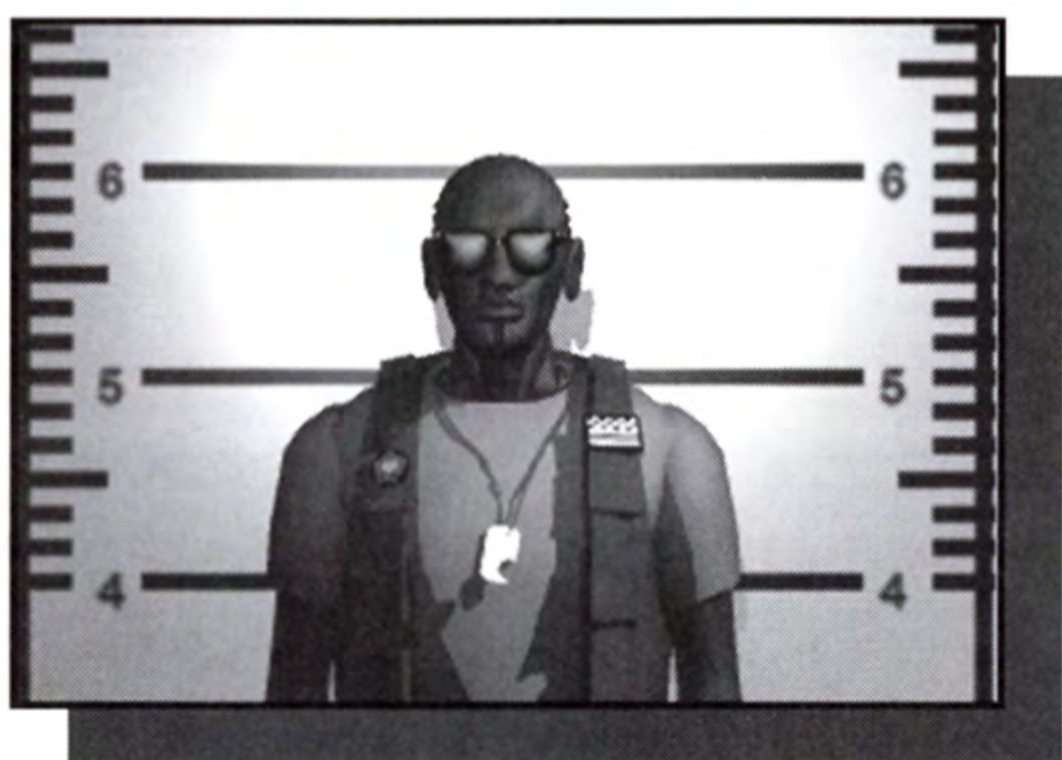

only member of Da Wardenz to know The Man's true identity.

Dogg-Tag

Real name: MIKE REYNOLDS

Rank: CAPTAIN

Age: 27 yrs

West Point educated and a one-time member of Special Forces, he is the leader of Da Wardenz and will brief you at the outset of each mission. Dogg Tag is the

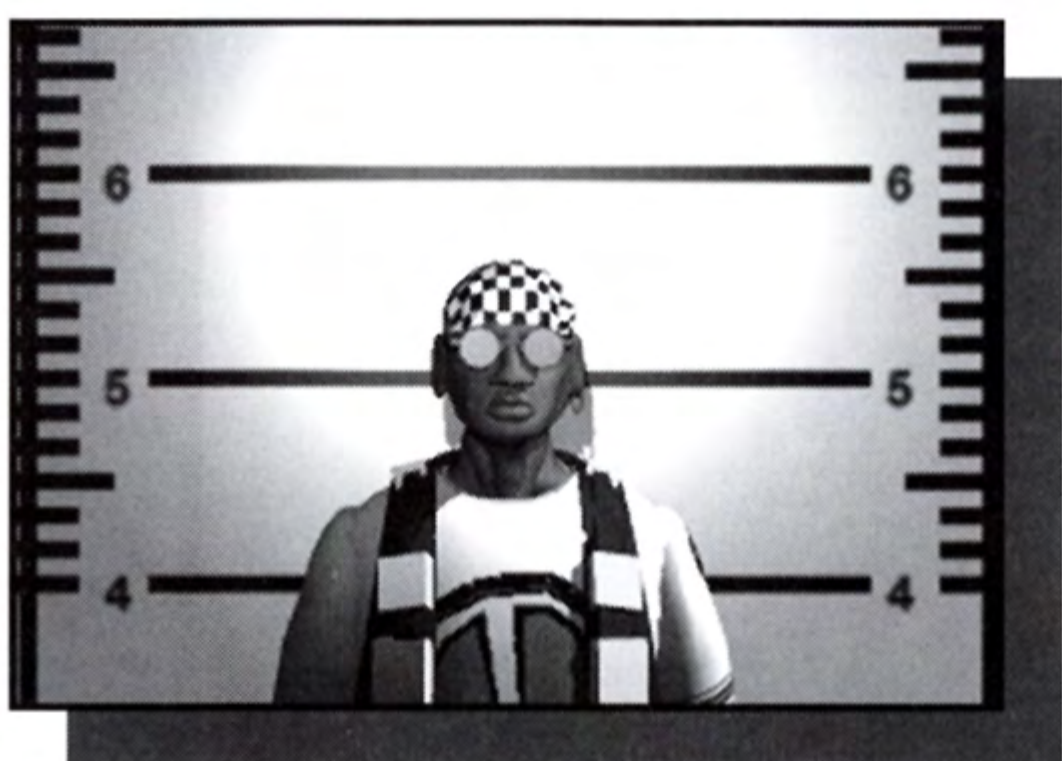

pilot, flying the A-10, for supporting air-cover. 9-1-1 is a very creative individual—he's the guy responsible for 'decorating' Da Wardenz vehicles.

9-1-1

Real name: CHARLES VALDEZ

Rank: LIEUTENANT

Age: 25 yrs

Also a graduate of West Point, 9-1-1 was a onetime member of a Special Forces unit attached to the Army Air Corps. He performs the role of Da Wardenz

THE M-13 PREDATOR BATTLETANK

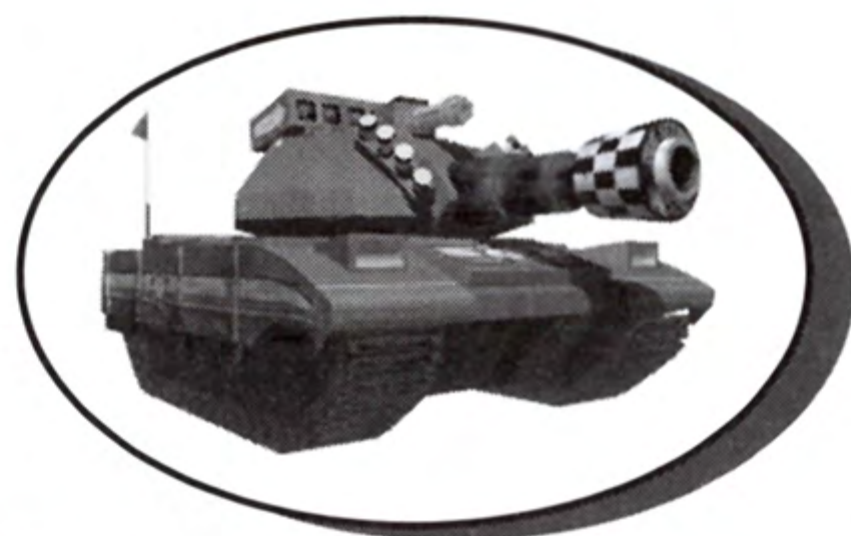

The word from D-Tour:

This is what you're gonna be playing with over the next few days and months. We're talking serious state-of-the-art mobile mayhem, here. The M-13 is what you need when you're rolling out into a real bad place like Mostvia Vatska and the stuff's really flyin'.

She's got a 240mm, M257, smooth-bore main cannon, capable of firing armor-piercing shells with great accuracy. She's got a 60mm, M231 pivoting chain-gun operated by a built-in targeting CPU that automatically tracks and locks on to both airborne and ground-based targets.

Your Predator can also be equipped with a surface-to-air missile launcher, loaded with up to 4 Viper, fire-and-forget SAMs. On the defensive side, this baby's got depleted uranium armor which you can upgrade and replace before going back into those firefights we all know and love so well.

And she's all yours, green. So take care of her and she'll take care of you.

STARTIN' OUT

SHELLSHOCK starts with an animated Introduction. The Introduction is followed by the Title Screen. From the Title Screen, press X to take you to the the virtual environment of Da Wardenz HQ.— known as THE PEN.

THE PEN

The Pen is located in the abandoned state correctional facility on Jackson Island, New York City. It is in here that you can explore the game's various options—accessing status screens, equipping your tank and entering Mission Briefings.

GETTIN' ROUND THE PEN

Gettin' round in the Pen couldn't be easier. All you gotta do is move a target-shaped cursor with the D-Pad between the several locations you can visit in the HQ. Text is overlaid at the bottom of the screen to describe each location and by pressing the "X" button on that location, you can access it.

HQ LOCATIONS



Main Hangar

From your 'home' location in the Main Hangar, you can access 4 main locations: Tank, Basketball Court, Workshop Area and Briefing Area.

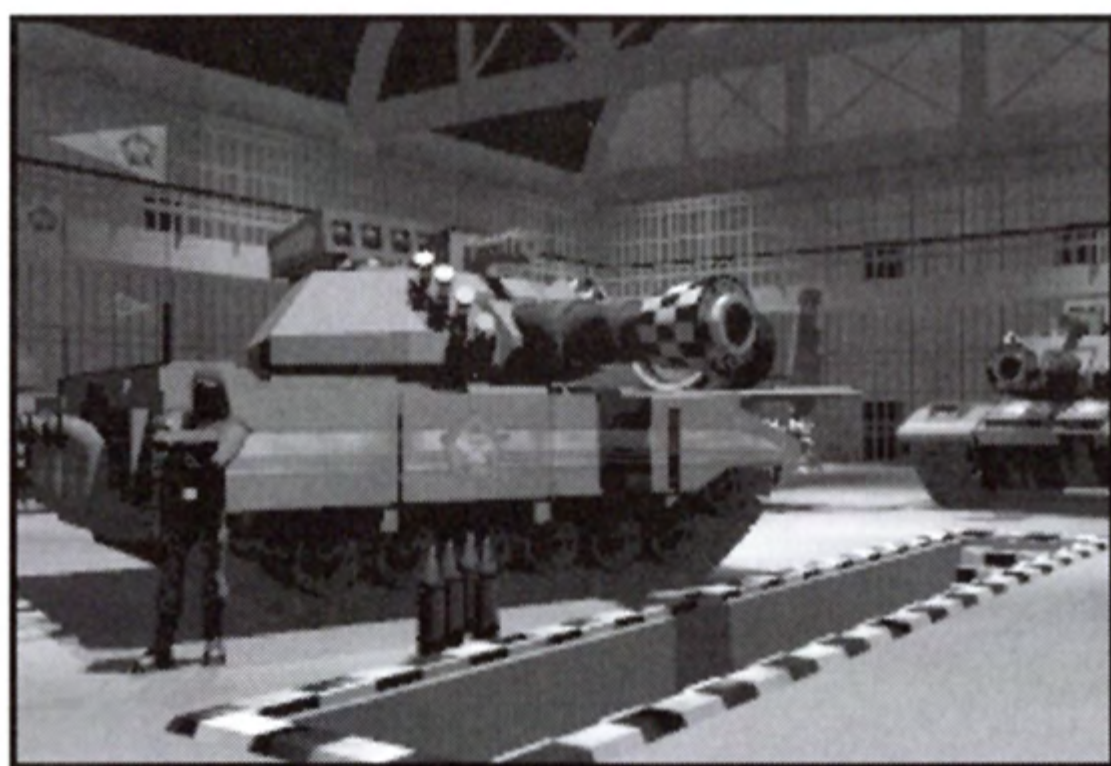

Tank

From here, you can climb aboard your M-13 Predator tank. Your options here are:

CLIMB ABOARD TANK

Inside the Predator's cockpit, you'll find some different controller setups to choose from. Follow the on-screen instructions.

EXIT

Takes you back to your 'home' location in the Main Hangar.

SHELLSHOCK

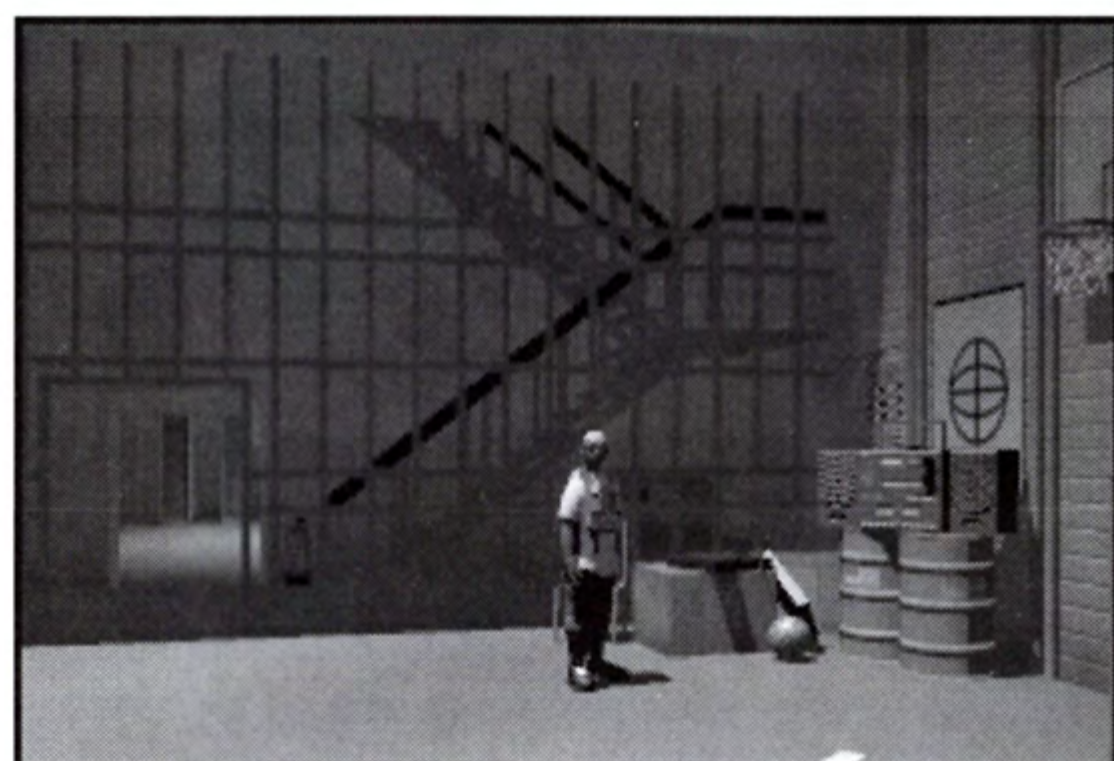

Basketball Court

Even though you can't shoot some hoops with 9-1-1, there's plenty to do in here:

GO TO STEREO SYSTEM

This is where you can listen to those funky beats.

EXIT

Takes you back to your 'home' location in the Main Hangar.

ENTER SIMULATION ROOM

Here you can talk to Earshot, your communications man.



Workshop Area

This is the place to check on your all-important status and to equip your tank.

CHECK STATUS

Accesses the Status Computers which will provide you with the Dateline for each mission (allowing you to check your progress thru the game), Tank Status (giving you the current level of armor fitted to your tank, the amount of damage you've got, and the level to which your tank's been equipped:

Armor Level:	The amount of armor fitted, and its strength.
SAMs:	How many missiles you have.
Engine Upgrades:	How much the engine's been upgraded (affecting acceleration, top speed and turning ability).
Track Upgrades:	How much your tracks have been upgraded (improving traction).

Reload Upgrades:	How well-tuned the reloading mechanism on the main cannon is (the time between each shot).
Targeting Upgrades:	How good your targeting computer is (speed of lock-on for chain-guns and missiles).
Cashflow:	How much cash you got.
Score:	How many points Dogg Tag's given you (or not, as the case may be).
Hit Accuracy:	How well you performed.

TALK TO PROPS

Now you're in touch with Props in the Stores and if you got the cash, you can upgrade your tank. The upgrades appear on the counter next to Props, so you can shop 'til you drop. These are the options in the Workshop Area:

Next Item:	Clicking on the D-Pad Left or Right lets you cycle through what's on offer.
Buy Item:	Clicking on the X Button lets you buy it (so long as you got the cash).
Leave Stores:	Hit <input type="checkbox"/> Button.

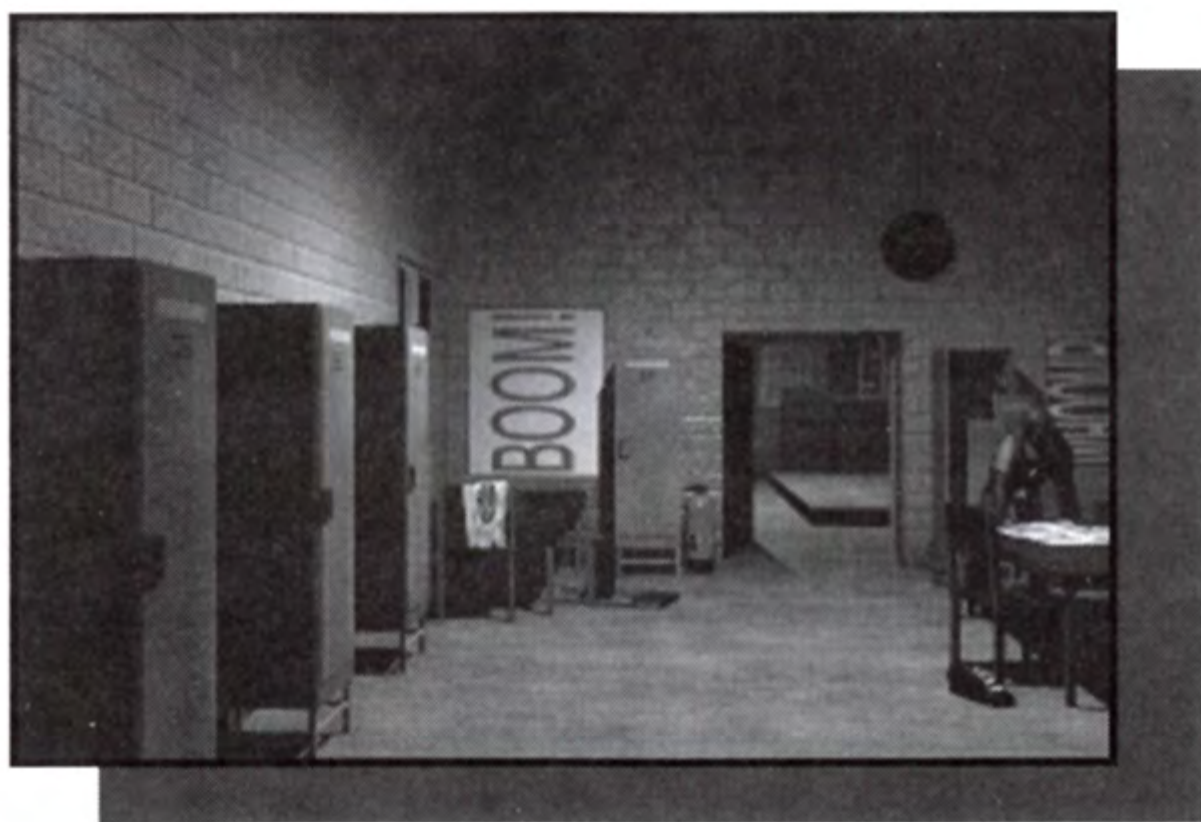

Briefing Area

This is the place where you lock and load the status of your game (save it) and go to the Mission Briefings. By moving the cursor over the first two lockers on show, you can "open" those lockers.

Locker 1 will Load Games, Locker 2 Saves Games.

Locker 1

Move the cursor over Locker 1 and press X Button. The Locker opens and you are given a list of any previous Save Games. There are a maximum of five save games per Memory Card. Any unoccupied slots are displayed as Empty Slot.

To Load a previously Saved Game select the slot you wish to load using the Up and Down Directional Buttons and press X Button. Your game will Load. Proceed to Briefing Room to commence Mission.

Locker 2

Move the cursor over Locker 2 and press X Button. The Locker opens and you are given a list of any previous Save Games. There are a maximum of five save games per Memory Card. Any unoccupied slots are displayed as Empty Slot.

To Save your current game select the slot you wish to Save it to using the Up and Down Directional Buttons and press X Button. Your game will Save.

Other options in the Briefing Area are:

- **ENTER BRIEFING ROOM**

Starts the Mission Briefing sequence for your current mission.

- **TALK TO DOGG-TAG**

Chew the fat with the main Wardenz man.

- **EXIT**

Takes you back to your 'home' location in the Main Hangar.

MISSION BRIEFINGS

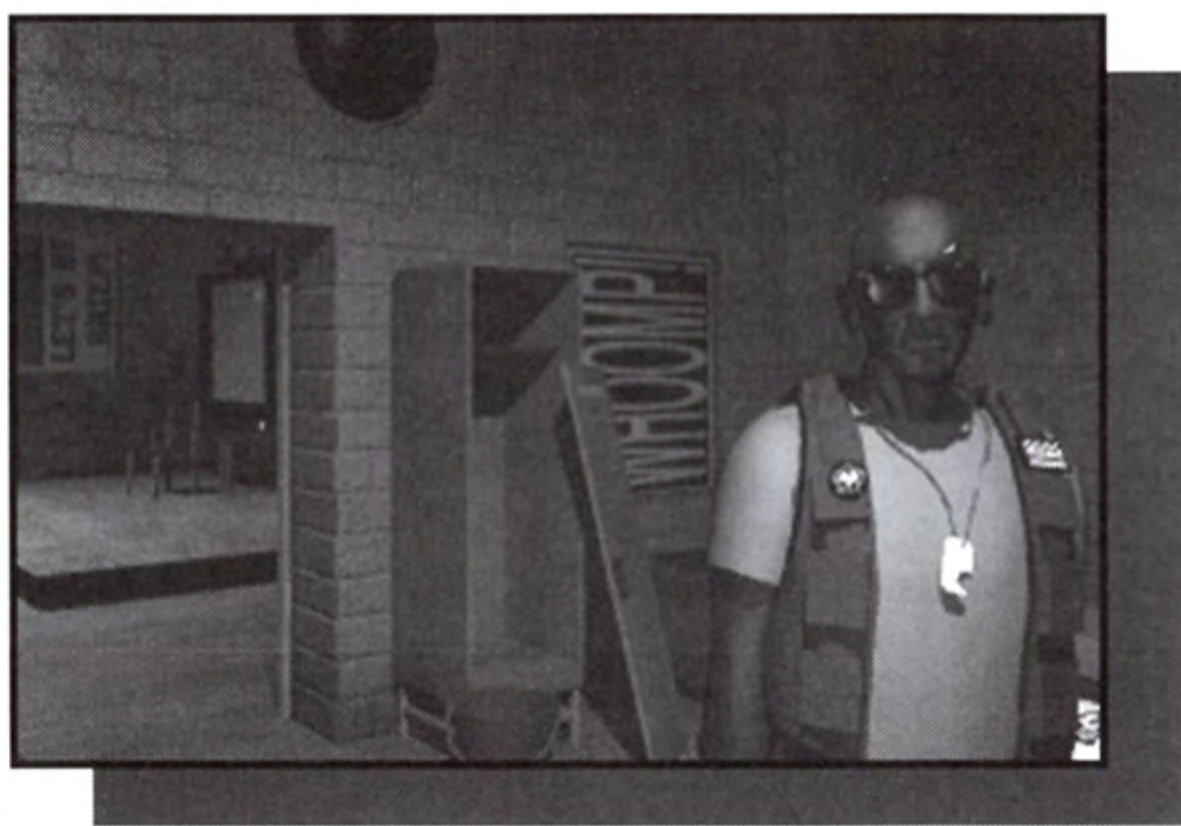

This is where you get the main rundown regarding each and every mission in the game. Dogg-Tag's the man with the plan in here and you better listen up and listen good if you want to stay alive. Sometimes The Man's talking to you and when he does, he'll be setting the scene with background details to the mission location.

Everything said in the briefings is vital to the successful completion of your missions, so you don't want to miss out on anything that's said (of course, you can always leave the briefings at any time if the call of nature's beckoning you, or you're one of those people who wants to get it on right away).

IN THE TANK

The cockpit of your M-13 Predator battletank is truly state-of-the-art. In here you got everything you need to help you take out those bad guys to maximum effect:

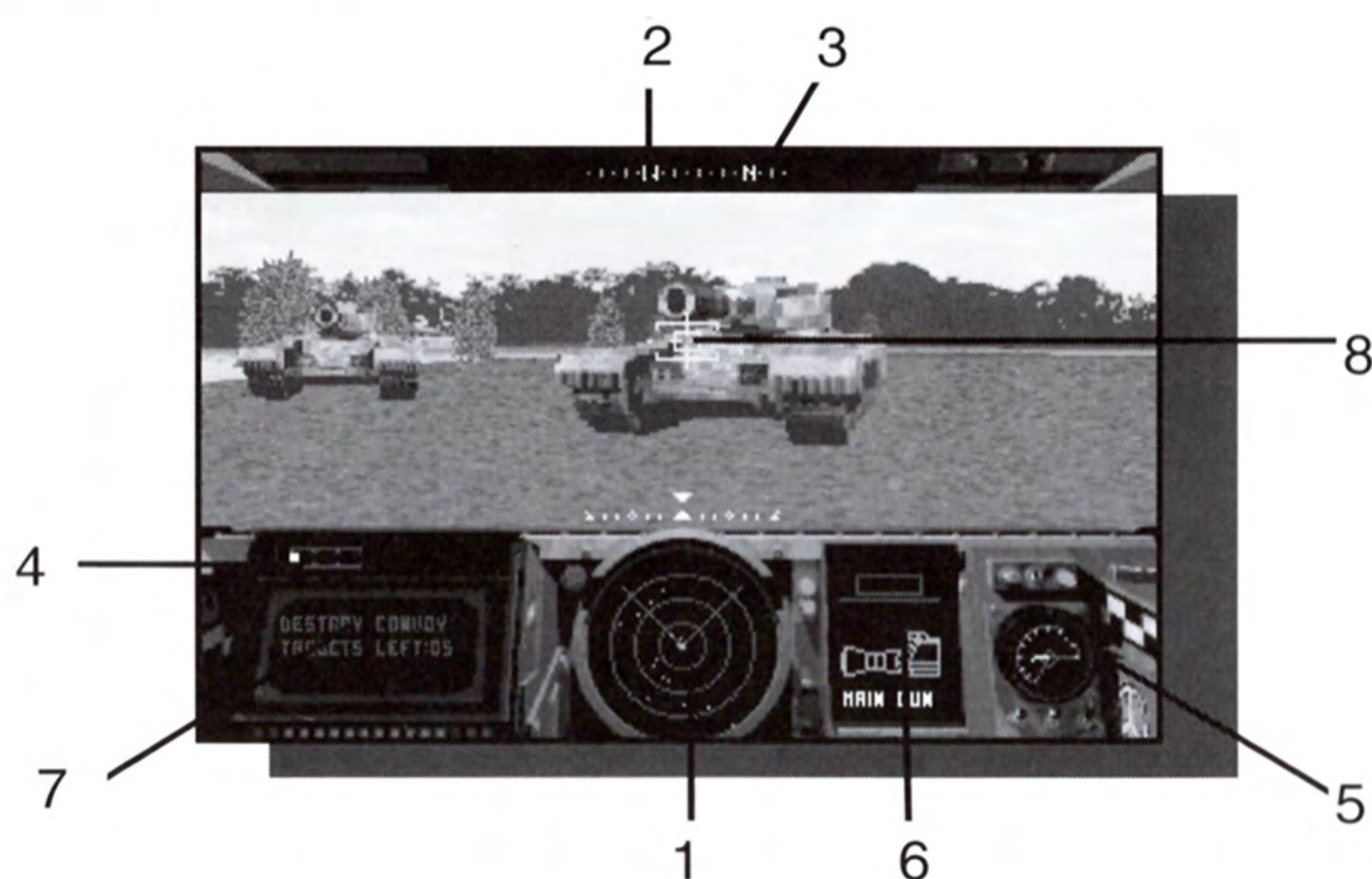

1. 360-4D 'Flack' Mk.I Threat Display

This is your radar. It plots the positions of all targets, bullets, shells and missiles, relative to your position. It also shows the position of your Main Gun Turret.

2. Kripps 'All Points' Roll-round Compass

A roll-round compass, with the central point showing your tank's current heading.

3. Flarelight 470 Mission Objective Indicator

The location of your next mission objective is shown by the two arrows situated to either side of the Compass. If they are both pointing right, then you go right. If they both point left, then you should go left. If the arrows are pointing inward and a third arrow appears in the center of the screen, then your objective is dead ahead.

4. A1 'Protector' Armor Integrity Indicator

This indicator shows the level of damage your tank has sustained and the level of armor it's currently equipped with.

5. Freeway Nine-five Speed Indicator

The moving needle on this display shows how fast you're going.

6. Weaport A-9 Weapons/Air-support Display

This display tells you which weapon you have currently selected along with some info about that weapon. For the Main Cannon, a cannon ready indicator is shown. For the chain-gun, a barrel temperature read-out and a lock-on indicator are shown. For surface-to-air missiles (SAMs), the number remaining and a lock-on indicator are displayed. This display also indicates what type of air-support you've called in and what's happening to that air-support.

7. Sanya Model 4 Multi-functional Display Monitor

This is where the rest of Da Wardenz may appear to give you various in-game messages.

8. Targeting Crosshair

Mercado I-12 Tactical Map Display

This is accessed by pushing the Display Tactical Map control. With the Tactical Map, you get a detailed lowdown on your current mission area.

ARMOR

Your Predator tank is fitted with highly effective, depleted uranium armor, capable of withstanding multiple hits from the bad guys' chain-guns and tank shells. The status of your tank's armor is always represented on-screen like this:



In the diagram above, each segment represents the amount of damage 2 shell hits from an enemy tank shell will cause to your tank's armor—each segment therefore representing 1 Armor Unit.

At the start of the game, your Predator is equipped with 3 Armor Units. During the game you can further equip your tank by buying a further 3 Armor Units.

WEAPONS

Your M-13 Predator battletank can be armed with 4 different weapons. However, only the Main Cannon and Chain-gun are available at the start of the game. To switch your weapon, use the Button.

240mm M257 Main Cannon

This is your big gun. Use it to take out ground targets. Aim the center-screen HUD (Heads Up Display) at the target and open fire. The Main Cannon has an unlimited supply of shells so you can blaze away without a care.

60mm M231 Chain-gun

This is your not-so-big gun. Use it to take out both air and ground targets. The Chain-gun locks on automatically to the nearest target and will remain locked on to it until it goes out of your direct line of sight or is destroyed. The Chain-gun takes a short while to lock-on, as its sight tracks across the screen to line up with the targeting crosshair (this is because it takes a little while for the gun to rotate into position). Once both sight and crosshair are overlaid, a lock-on will flash and the gun will remain trained on the target.

Milipps Systems 'Viper' Surface-to-air Missiles (SAMs)

These are limited in number, must be bought from the Stores and only 4 may be fitted to your tank at any one time. SAMs can only be used against threats from the air and require a lock-on before they can be fired. Once a lock-on has been achieved (in the same way as the Chain-gun) and the missile fired, it will home in on the target until said target has been destroyed—providing that the target is within range of your radar Threat Display.

TANK UPGRADES

A Note from Props:



If you wanna be a winner you gotta spend those dollars—speculate to accumulate. During the course of your stay with us, you're gonna be wanting to upgrade your tank's performance and you can do that by buying any of the following from my good self at the Stores.



Armor Repair

This repairs your tank's armor by 1 Armor Unit.



Extra Armor

This adds a new piece of armor—equivalent to 1 Armor Unit—to your Predator battletank. Because this is a brand spanking new piece of high-grade, depleted uranium armor, the current armor strength of your tank will also go up by 1 Armor Unit.



SAMs

You can buy up to 4 of these. None are fitted to your tank at the start of the game.

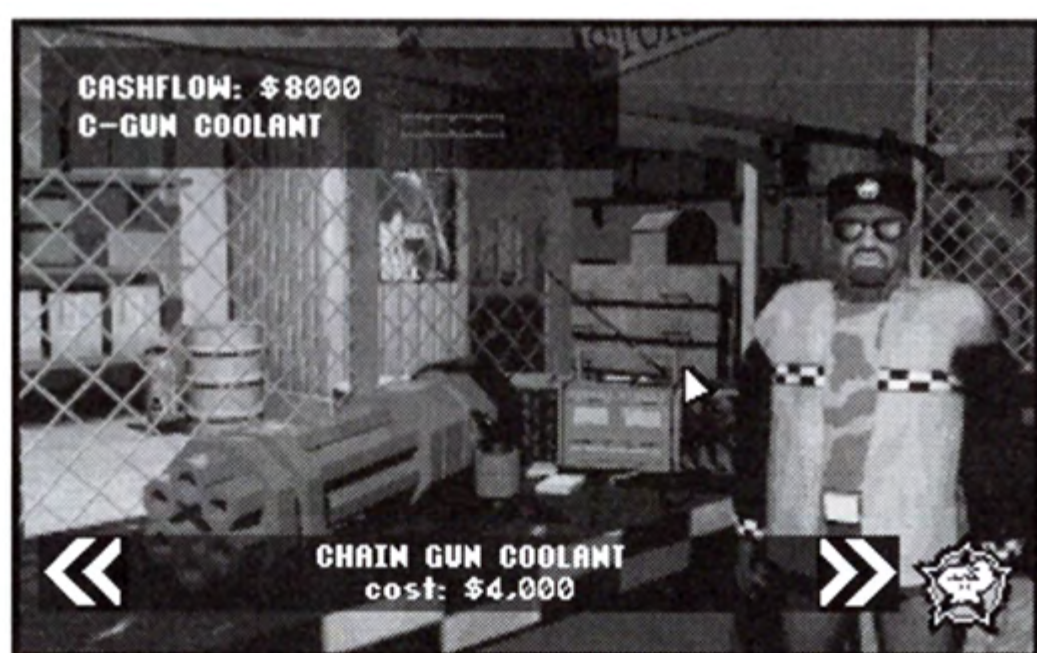

Chain Gun Coolant

This will upgrade the speed at which your Chain Gun is reloaded.



Reload Mechanism Upgrade

This will slightly improve the speed of reloading your tank's main cannon, therefore increasing your rate of fire. My advice to you is to purchase several of these to achieve maximum performance.



Targeting Computer Upgrade

This will upgrade your Predator's targeting CPU so's you can achieve a lock-on with both chain-gun and SAMs a lot faster. Once again, my advice is to buy several of these to achieve maximum effect.



Engine Upgrade

Buying an Engine Upgrade will increase your tank's acceleration, top speed and the speed of rotation (maneuverability). Buy a whole bunch—but make sure you also got Tracks Upgrades too. There's no point having great acceleration unless you have the traction to use it.

SHELLSHOCK



Tracks Upgrade

This upgrade improves the traction of your Predator's tracks, enabling them to get a much better grip on surfaces. The downside of this is that you may find your tank's top speed adversely affected. Buy several for maximum traction.



Offensive Air Support

Fuelling up the Nine's A-10 is an expensive operation—and when you add the ordnance on top of that, we're talking serious money here. But you're gonna wish you had that flyboy helping you out at the earliest opportunity, so start saving now. Nine does a single run per mission. No more. No less.

AIR SUPPORT

A note from 9-1-1:



They call me 9-1-1—you gotta problem?—Just call on Nine.

Offensive Air Support

This is basically your fourth main weapon, acting like a big smart bomb. When you call me in, you'll hear me before you see me. Then it's bye-bye to the bad guys.

HOSTAGES

A note from Earshot:



Listen up and listen good. This is the lowdown on hostage rescue.

When you drive your tank to within a certain range of a hostage, they'll run toward you and subsequently climb aboard—but only if you're stationary. Don't move, or you might squish 'em!

If the hostage is moving too far away from cover, i.e., if you're driving away from him, then he's going to be turning back and getting out of the line of fire, back to his original hidey-hole. He's gonna wait there until you return to fetch him.

ENEMY VEHICLES

All enemy vehicles have recognizable profiles. Learn to distinguish a basic tank from a heavy battletank.

Stationary Ground Threats

GUN EMPLACEMENTS

Small enclosures with a chain-gun fixed into a set position, but with a 90 degree arc of fire. Use your Chain Gun to take them out.

Mobile Ground Threats



TANKS

Same as yours. They'll hit you hard if you give 'em the chance.

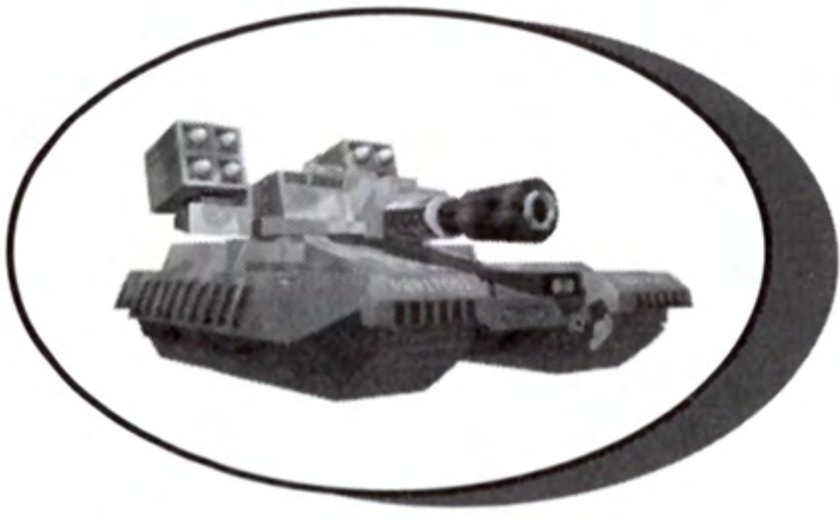

HEAVY BATTLETANKS

These babies take more hits than their little brothers, but they aren't as fast.



LIGHT ARMORED FIGHTING VEHICLES (AFVs)

Highly maneuverable, light tanks. Small but deadly, so watch out for these guys



ARMORED PERSONNEL CARRIERS (APCs)

Identical to the Battletank when maneuvering, the APC's armed with a chain-gun with a 90 degree arc of fire.

Waterborne Threats



GUNBOATS

Restricted to areas of deep water, they've got a chain-gun mounted on their bows which has a 90 degree arc of fire.

Airborne Threats



LIGHT ATTACK HELICOPTERS

Armed with a chain-gun, these choppers go into a hover before opening up on you.



HELICOPTER GUNSHIPS

Real bad news. Basically, a flying tank attacking you with missiles and a whole heap of other stuff that I don't even want to think about...

PICK-UPS

Supply Crates

Just drive over `em to collect what they holding. Back at HQ, you can cash in at the stores.

MISSION STATS.

At the end of each mission, you'll be presented with a statistical breakdown of how you did. These stats will include Hit Accuracy, No. of Targets Destroyed, Mission Objectives Achieved, etc.

SHELLSHOCK

The last word from Dogg Tag:



Someone once said, 'It doesn't matter whether you win or lose, it's how you play the game.'

Well that man was wrong.

I want you to go out there and win. At all costs...

So what are you waiting for?
Let's do it...

Listen carefully to the Mission Briefings, or you'll be shooting in the dark!

CREDITS

Core Design Presents: SHELLSHOCK

Lead Programmer

Mansoor Nusrat

Production Design and Graphics

Simon Phipps

Game Design

Simon Phipps, Guy Miller, Mansoor Nusrat, Martin Iveson

James Ryman, Mark Price, Adrian Smith

Network Game Programming

David Muir

Presentation Programming

David Long

Support Programmers

Mark 'Mac' Ivory, Sean Dunlevy, Martin Gibbins

John Kirkland, Derek Leigh-Gilchrist, Chris Long

Mission Design

Titsiano Cirillo, Guy Miller, Jamie Morton

Simon Phipps, Darren Price, David Ward

Music and Sound Effects

Martin Iveson

Rap Vocals

William Floyd (BAR NONE)

Background Vocals

Lynn Ray, Annie Stocking

Lyrics

William Floyd

Vocal Tracks Produced by

James Grunke

Vocal Tracks Engineered by

Mary Ellen Perry

Assistant Engineers On Vocal Tracks

Greg Byrne, Rafi Kaufman

Script Written by

Guy Miller, Simon Phipps

Additional Scriptwork

DMP Entertainment

Voice Overs

DOGG-TAGG — Nicolas Jones

D-TOUR — Fred Martin

9-1-1 — Cory Bell

PROPS — Alan Bruce

EARSHOT — Hansfer Prince

THE MAN — Guy Miller

JULIA FREEMAN — Rachel Fyffe

Ms. Freeman's Make-up Design

Susie Hamilton

Quality Assurance

Titsiano Cirillo, Frank Hom, Tom Marx, Jamie Morton

Darren Price, Brian Schorr, Mike Schmitt, David Ward

Dan Wong, Dan Lam, Steve Dreo, Ricky Chow

SHELLSHOCK

Marketing Support (U.K.)

Richard Barclay, Susie Hamilton
Andrew Thompson, Barry Townley

Marketing Support (U.S.A.)

Sean Mylett, Jill DeMaria
Sutton Trout, Kelly Lindlar
Lee Wilkinson, Mary Lynn Slattery
John Lee

Production Co-ordination (UK)

Adrian Smith, Troy Horton

Producer (USA)

Mike Schmitt

Executive Producer

Jeremy Smith

Special Thanks

Robert Botch, Don "It's Done!" Maggi, Joseph Olin, Kent Russell,
David Platshon, Daryn Roven, Pete Duncan, The Music Annex,
Russian Hill Recording Studios.

U.S. GOLD INC, LIMITED WARRANTY

U.S. GOLD, INC. warrants to the original purchaser that this U.S. GOLD disk is free from defects in materials and workmanship for a period of ninety (90) days from the date of purchase. This U.S. GOLD disk is sold "as is" without expressed or implied warranty of any kind, and U.S. GOLD is not liable for any losses or damages of any kind resulting from use of this program. U.S. GOLD agrees for a period of ninety (90) days to either repair or replace, at its option, free of charge, any U.S. GOLD disk, postage paid, with proof of date of purchase, at its Factory Service Center.

This limited warranty is not applicable to normal wear and tear. This limited warranty shall not be applicable and shall be void if the defect in the U.S. GOLD disk has arisen through abuse, unreasonable use, mistreatment or neglect. This limited warranty is in lieu of all other warranties and no other representations or claims of any nature shall be binding on or obligate U.S. GOLD. Any implied warranties of merchantability and fitness for a particular purpose, are limited to the ninety (90) day period described above. In no event will U.S. GOLD be liable for any special, incidental, or consequential damages resulting from possession, use or malfunction of this disk.

Some states do not allow limitation as to how long an implied warranty lasts and/or exclusions or limitations or incidental or consequential damages so the above limitations and/or exclusions of liability may not apply to you. This warranty gives you specific rights, and you may also have other rights which vary from state to state.

Our HELP Line number is (415) 693-0497. Customer service is available Monday through Friday 9:00AM to 5:00PM Pacific Time.



NTSC U/C

SHELLSHOCK

PlayStation

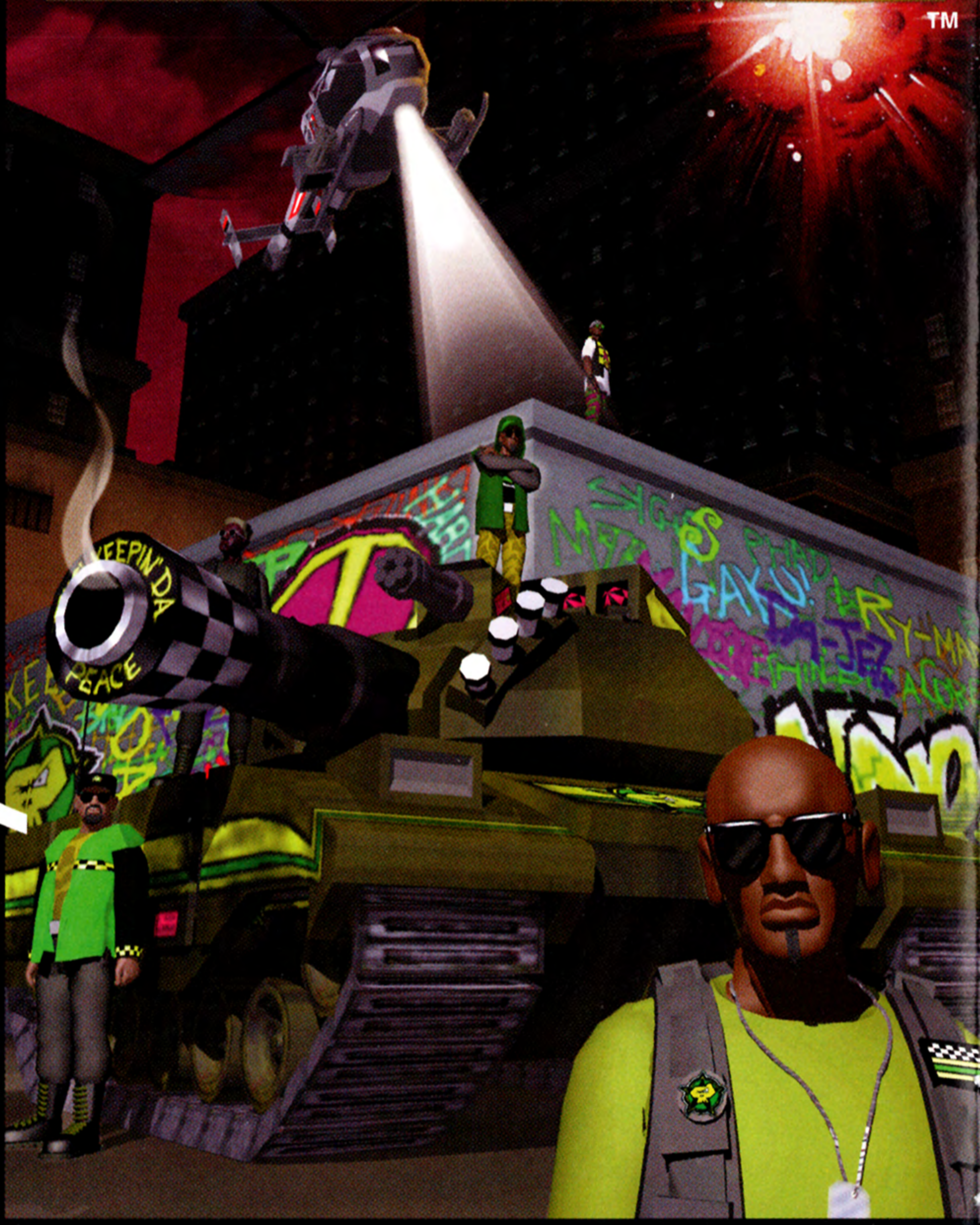

SLUS-00031

U.S. Gold Inc., 303 Sacramento Street, San Francisco, CA 94111. Shellshock © 1995 U.S. Gold Inc.

Licensed by Sony Computer Entertainment America for use with the PlayStation game console. PlayStation, the PlayStation logo and the PS logo are trademarks of Sony Computer Entertainment America. The ratings icon is a registered trademark of the Interactive Digital Software Association. Manufactured and printed in U.S.A.

U.S. and foreign patents pending.

